

# E3S-CL



## Simply Set the Distance to Reliably Detect Workpieces of Various Colors

- Reliable detection regardless of color or material. Black/white error of only 2% max. (E3S-CL1)
- Long sensing distance of 500 mm (E3S-CL2).
- Eliminates background influence. (Differential travel of only 2% max. with E3S-CL1.)
- Metal body with IP67 protection. Oil resistance (E3S-CL2).



 Be sure to read *Safety Precautions* on page 7.

For the most recent information on models that have been certified for safety standards, refer to your OMRON website.

## Ordering Information

**Sensors** (Refer to *Dimensions* on page 8.)

 Red light  Infrared light

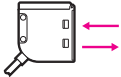
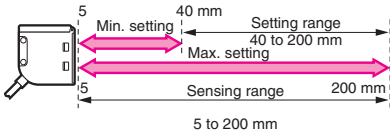
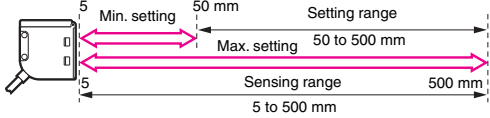
| Appearance  | Sensing/Setting range   | Model             |
|---|---|-------------------|
|  |  <p>5 40 mm Setting range<br/>Min. setting 40 to 200 mm<br/>Max. setting<br/>Sensing range 200 mm<br/>5 to 200 mm</p>   | <b>E3S-CL1 2M</b> |
|   |  <p>5 50 mm Setting range<br/>Min. setting 50 to 500 mm<br/>Max. setting<br/>Sensing range 500 mm<br/>5 to 500 mm</p> | <b>E3S-CL2 2M</b> |

## Ratings and Specifications

| Sensing method   |                         | Distance-settable  |  |
|--|-------------------------|--|--|
| Item   | Model                   | E3S-CL1  | E3S-CL2  |
| <b>Sensing distance</b>                                    |                         | 5 to 200 mm (white paper: 200 x 200 mm, setting distance: 200 mm)  | 5 to 500 mm (white paper: 200 x 200 mm, setting distance: 500 mm)                |
| <b>Setting range</b>                                       |                         | 40 to 200 mm (white paper: 200 x 200 mm)   | 50 to 500 mm (white paper: 200 x 200 mm)   |
| <b>Differential travel</b>                                 |                         | 2% max. of setting distance  | 10% max. of setting distance   |
| <b>Reflectivity characteristics (black/white error) *1</b> |                         | 2% max. of setting distance  | 10% max. of setting distance   |
| <b>Light source (wavelength)</b>                           |                         | Red LED (660 nm)   | Infrared LED (850 nm)  |
| <b>Power supply voltage</b>                                |                         | 10 to 30 VDC; ripple: 10% max.   |  |
| <b>Current consumption</b>                                 |                         | 35 mA max.   | 50 mA max.   |
| <b>Control output</b>                                      |                         | Load power supply voltage: 30 VDC max., Load current: 100 mA max.<br>Residual voltage: NPN output: 1.2 V max.<br>PNP output: 2 V max.<br>Open collector output (NPN/PNP depending on model)<br>Light-ON/Dark-ON selectable |  |
| <b>Protection circuits</b>                                 |                         | Power supply reverse polarity protection, Output short-circuit protection, Mutual interference prevention  |  |
| <b>Response time</b>                                       |                         | Operate or reset: 1 ms max.  | Operate or reset: 2 ms max.  |
| <b>Distance setting</b>                                    |                         | Six-turn endless adjuster with an indicator  |  |
| <b>Ambient illumination (Receiver side)</b>                |                         | Incandescent lamp: illumination on optical spot: 5,000 lx max.<br>Sunlight: illumination on optical spot: 10,000 lx max.   |  |
| <b>Ambient temperature range</b>                           |                         | Operating: -25 to 55°C, Storage: -40 to 70°C (with no icing or condensation)   |  |
| <b>Ambient humidity range</b>                              |                         | Operating: 35% to 85%, Storage: 35% to 95% (with no condensation)  |  |
| <b>Insulation resistance</b>                               |                         | 20 MΩ min. at 500 VDC  |  |
| <b>Dielectric strength</b>                                 |                         | 1,000 VAC, 50/60 Hz for 1 min  |  |
| <b>Vibration resistance</b>                                |                         | Destruction: 10 to 55 Hz, 1.5-mm double amplitude for 2 hrs each in X, Y, and Z directions   |  |
| <b>Shock resistance</b>                                    |                         | Destruction: 500 m/s <sup>2</sup> 3 times each in X, Y, and Z directions   |  |
| <b>Degree of protection</b>                                |                         | IP67 (IEC 60529), NEMA: 6P (indoors only) *2   | IP67 (IEC 60529) (in-house standards: oil-resistant), NEMA: 6P (indoors only) *2 |
| <b>Connection method</b>                                   |                         | Pre-wired (standard length: 2 m)   |  |
| <b>Weight (packed state)</b>                               |                         | Approx. 170 g  |  |
| <b>Materials</b>   | <b>Case</b>             | Zinc die-cast  |  |
|  | <b>Operation panel</b>  | PES (Polyether sulfone)  |  |
|  | <b>Lens</b>             | Methacrylic resin  |  |
|  | <b>Mounting bracket</b> | Stainless steel (SUS304)   |  |
| <b>Accessories</b>   |                         | Mounting bracket, 12 M4 hexagonal bolts (with spring and flat washers), Adjustment screwdriver, and Instruction manual   |  |

\*1. Sensing distance error for standard white (90% reflective) and black (5% reflective) paper.

\*2. NEMA: National Electrical Manufacturers Association

Engineering Data (Reference value)

Operating Range

E3S-CL1

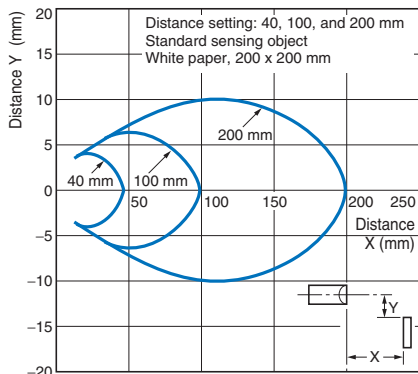

E3S-CL2

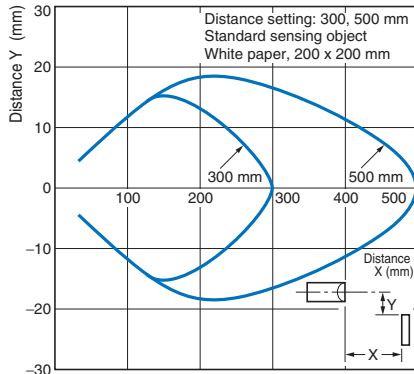

Sensing Object Size vs. Sensing Distance

E3S-CL1

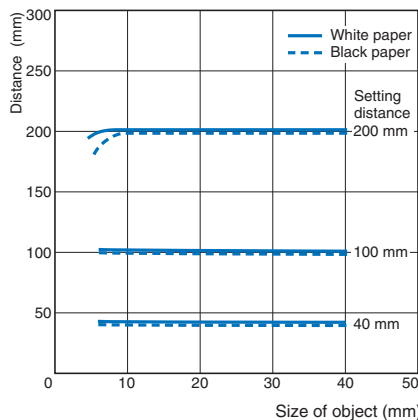

E3S-CL2

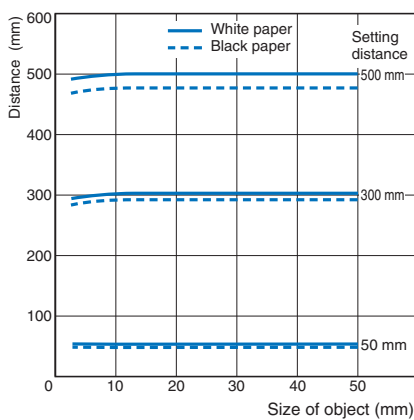

Spot Diameter vs. Sensing Distance

E3S-CL1

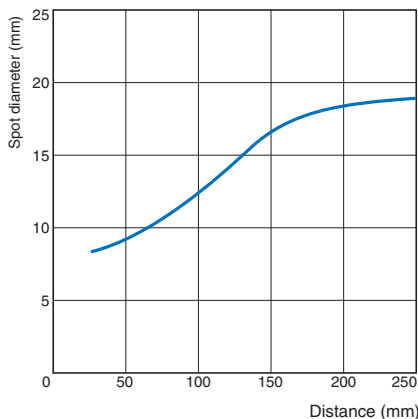

E3S-CL2

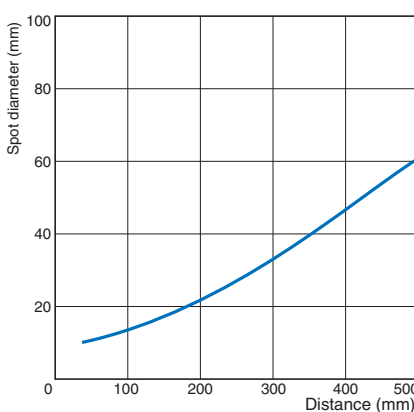

Sensing Distance vs. Minimum Detectable Object Size

E3S-CL1

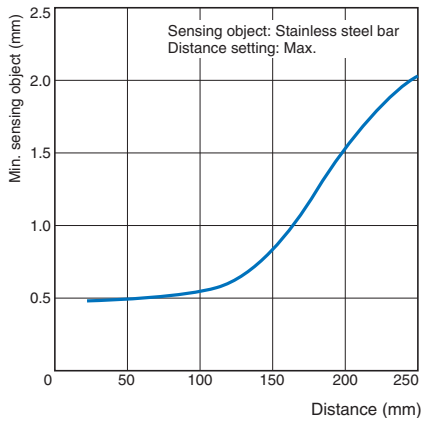

E3S-CL2

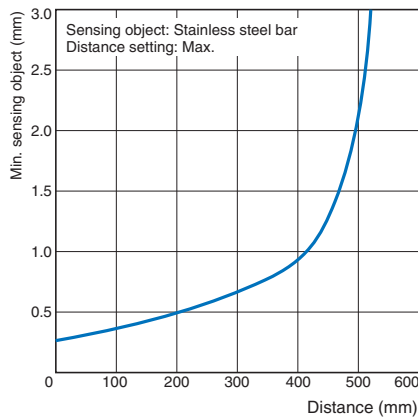

Sensing Object Angle Characteristics

E3S-CL1 Vertical

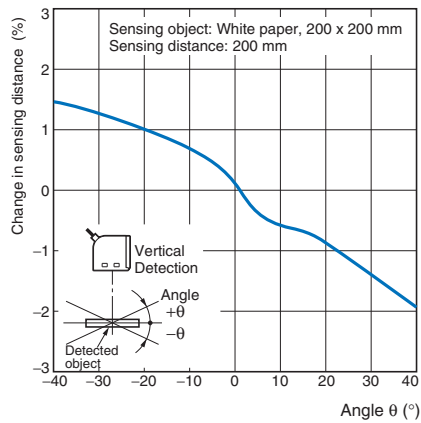

E3S-CL1 Horizontal

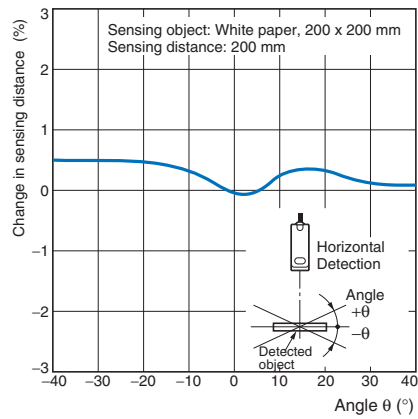

E3S-CL2 Vertical

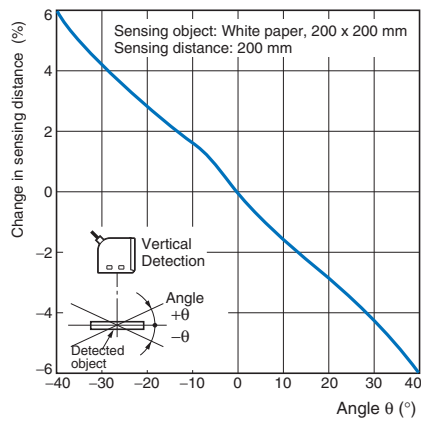

E3S-CL2 Horizontal

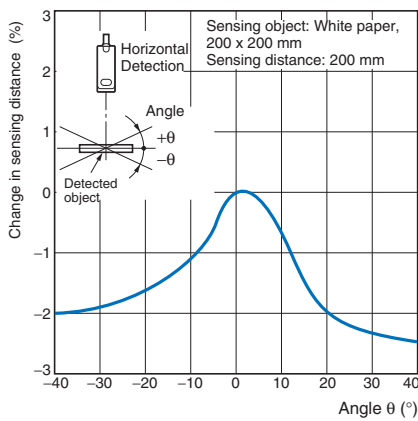

Sensing Distance vs. Sensing Object Material

E3S-CL1

(Setting Distance of 200 mm using White Paper)

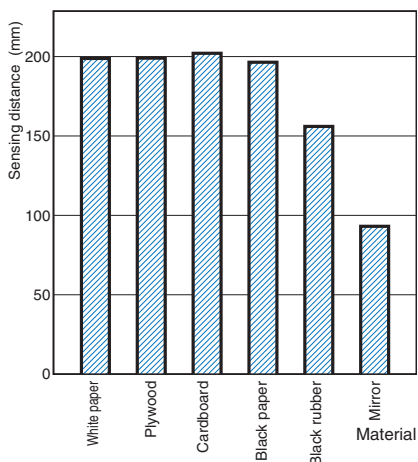

(Setting Distance of 100 mm using White Paper)

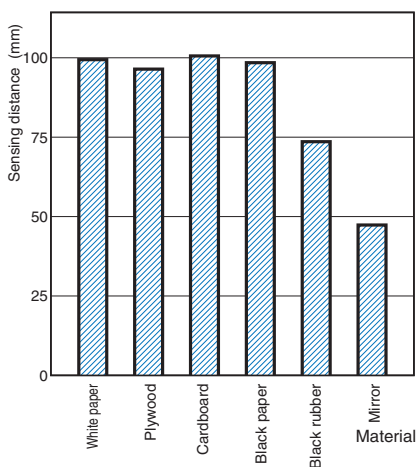

(Setting Distance of 40 mm using White Paper)

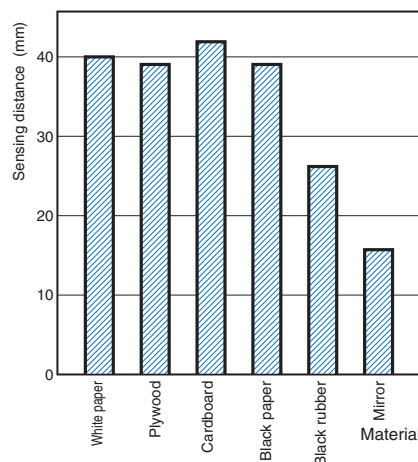

E3S-CL2

(Setting Distance of 500 mm using White Paper)

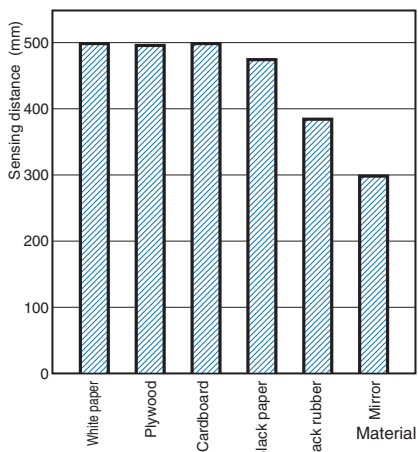

(Setting Distance of 300 mm using White Paper)

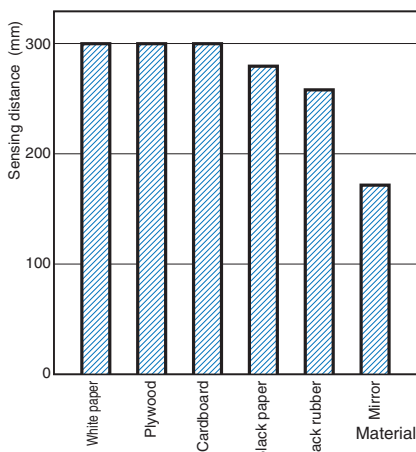

(Setting Distance of 50 mm using White Paper)

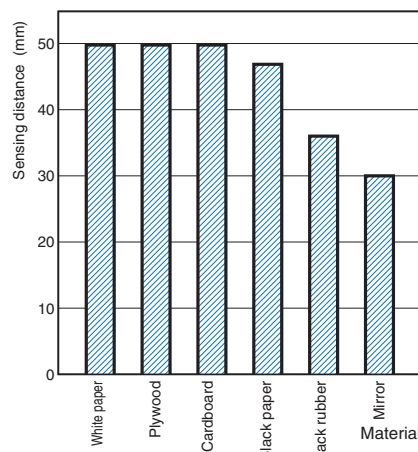

Close-range Characteristics

E3S-CL1

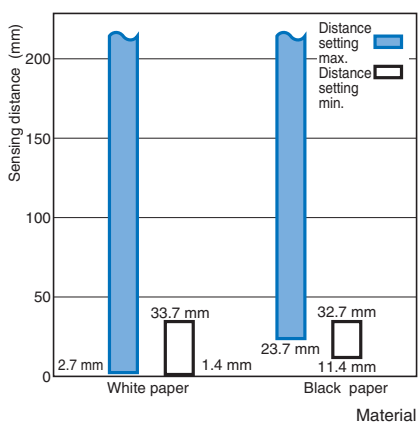

E3S-CL2

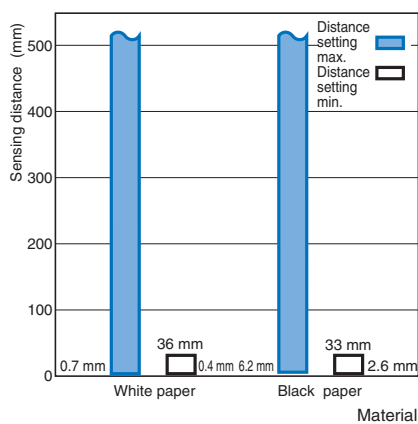

## I/O Circuit Diagrams

### NPN Output

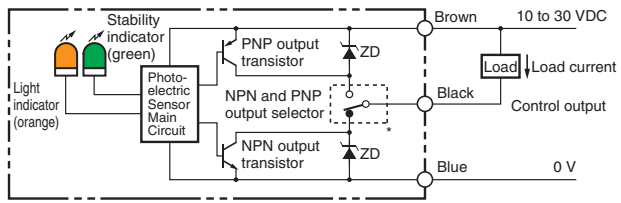
| Model              | Operation mode | Timing charts  | Operation selector | Output circuit   |
|--------------------|----------------|--|--------------------|--|
| E3S-CL1<br>E3S-CL2 | Light-ON       | Incident light: ON (green bar)<br>No incident light: OFF (white bar)<br>Operation indicator (orange): ON (orange bar)<br>OFF (white bar)<br>Output transistor: ON (green bar)<br>OFF (white bar)<br>Load (relay): Operate (green bar), Reset (white bar) | L side (LIGHT ON)  |  <p>*Set the NPN and PNP output selector to NPN.</p> |
|                    | Dark-ON        | Incident light: ON (green bar)<br>No incident light: OFF (white bar)<br>Operation indicator (orange): ON (orange bar)<br>OFF (white bar)<br>Output transistor: ON (white bar), OFF (green bar)<br>Load (relay): Operate (white bar), Reset (green bar)   | D side (DARK ON)   |  |

### PNP Output

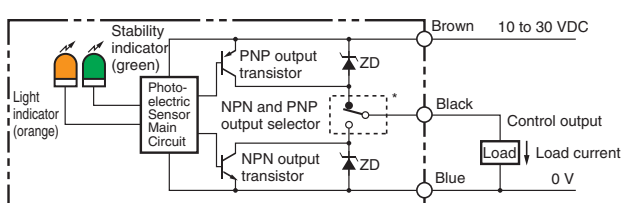
| Model              | Operation mode | Timing charts  | Operation selector | Output circuit  |
|--------------------|----------------|--|--------------------|---|
| E3S-CL1<br>E3S-CL2 | Light-ON       | Incident light: ON (green bar)<br>No incident light: OFF (white bar)<br>Operation indicator (orange): ON (orange bar)<br>OFF (white bar)<br>Output transistor: ON (white bar), OFF (green bar)<br>Load (relay): Operate (white bar), Reset (green bar) | L side (LIGHT ON)  |  <p>*Set the NPN and PNP output selector to PNP.</p> |
|                    | Dark-ON        | Incident light: ON (green bar)<br>No incident light: OFF (white bar)<br>Operation indicator (orange): ON (orange bar)<br>OFF (white bar)<br>Output transistor: ON (white bar), OFF (green bar)<br>Load (relay): Operate (white bar), Reset (green bar) | D side (DARK ON)   |   |

## Nomenclature

### Operation Panel

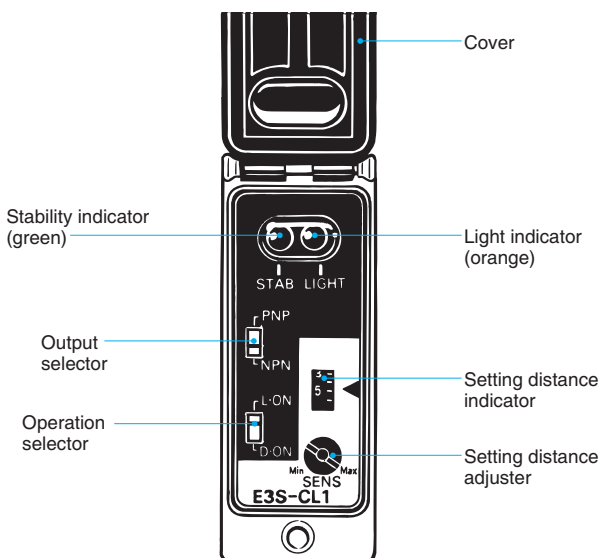

### Output Selector

1. Set the selector to NPN for NPN output.
2. Set the selector to PNP for PNP output.

### Operation Selector

1. Set the selector to L-ON for ON light-ON operation.
2. Set the selector to D-ON for ON dark-ON operation.

### Setting Distance Adjuster

1. The sensing distance will increase when the adjuster is turned clockwise (toward Max.) and will decrease when the knob is turned counterclockwise.
2. The adjustment can be turned up to 6 times clockwise or counterclockwise to set the sensing distance. The number of turns will be displayed by the indicator.

## Safety Precautions

Refer to *Warranty and Limitations of Liability*.

### ⚠ WARNING

This product is not designed or rated for ensuring safety of persons either directly or indirectly. Do not use it for such purposes.



### Precautions for Correct Use

Do not use the product in atmospheres or environments that exceed product ratings.

#### ● Designing

##### Cable

The E3S-CL2 uses an oil-resistive cord to ensure oil resistivity.

#### ● Mounting

##### Mounting

##### Mounting Direction

- Mount the Sensor so that the sensing face runs parallel to the surface of the object being detected as shown below, and not at an angle.

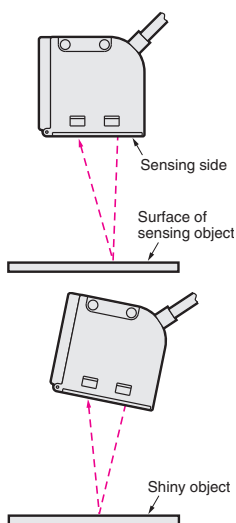

If detecting a shiny object, however, mount the Sensor so that the sensing face is at an angle of between 5° and 10° of the surface of the object being detected as shown below, and check to be sure that there is no interference from the background.

- If stable operation is not possible near a mirror surface, mount the Sensor at an angle as shown below, and separate the Sensor as far as possible from the mirror surface.

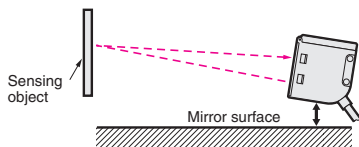

- Mount the Sensor so that it is not aligned with the direction of movement of the sensing object, as shown below.

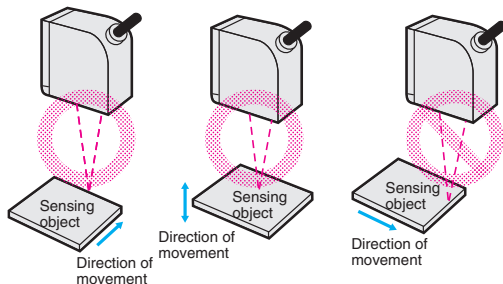

- Also, mount the Sensor so that it is not aligned with extreme changes in color or materials, as shown below.

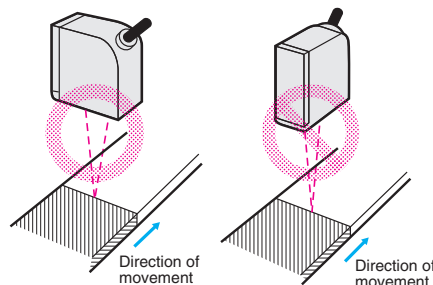

- Mount the Sensor so that sunlight, fluorescent light, incandescent light, or other strong sources of light do not enter the directional angle of the Sensor.

#### Precautions

- When mounting the Sensor, do not hit the Sensor with a hammer, or the Sensor will lose its watertightness.
- Use M4 screws to mount the Sensor.
- The tightening torque of each screw must be 1.2 N·m maximum.

#### ● Others

##### Oil and Chemical Resistivity (E3S-CL2)

The E3S-CL2 was tested for resistance to the oils given in the following table. Refer to the information in the table when deciding which type of oil to use. However, performance may be affected by certain types of oil.

| Test oil classification       | Product name  | Kinematic viscosity (mm <sup>2</sup> /s (cst)) at 40°C | pH       |
|-------------------------------|---|--|----------|
| Lubricating oil               | Velocity No.3 (manufactured by Exxon Mobil)                                 | 2.02   |          |
| Water insoluble machining oil | Yushiron Oil No. 2 ac (manufactured by Yushiro Chemical Industry Co., Ltd.) | Less than 10   | ---      |
| Water soluble machining oil   | Yushiroken EC50T-3 (manufactured by Yushiro Chemical Industry Co., Ltd.)    | ---  | 7 to 9.5 |
|                               | Yushiron Lubic HWC68 (manufactured by Yushiro Chemical Industry Co., Ltd.)  |  | 7 to 9.9 |
|                               | Gryton 1700D (manufactured by Toho Chemical Industry Co., Ltd.)             |  | 7 to 9.2 |
|                               | Yushiroken S50N (manufactured by Yushiro Chemical Industry Co., Ltd.)       |  | 7 to 9.8 |

Note: 1. The E3S-CL2 maintained a minimum insulation resistance of 100 MΩ after it was dipped in all the above oils at a temperature of 50°C for 240 hours.

2. When using the E3S-CL2 in environments subject to oils other than those listed above, use the figures for kinematic viscosity and pH values from the table as general guidelines. Additives and other substances contained in oils may affect the E3S-CL2. Be sure to consider this before use.

## Dimensions

E3S-CL1

E3S-CL2

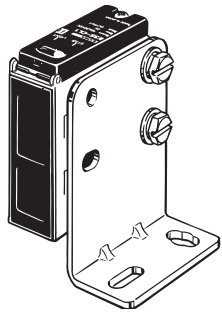

With Mounting Bracket Attached

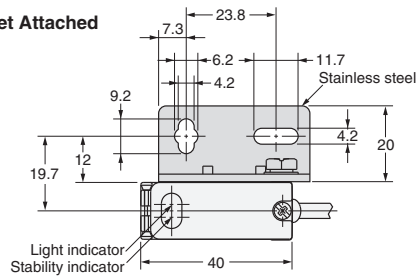

Mounting Holes

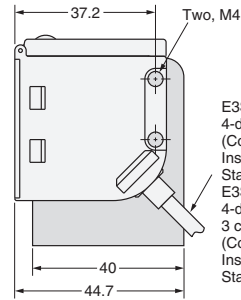
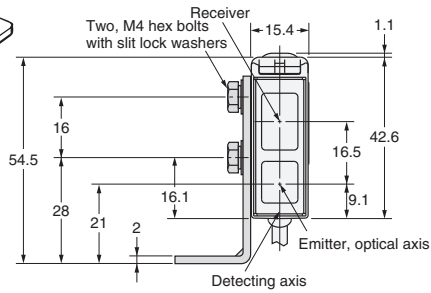
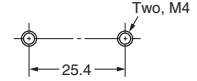

E3S-CL1:  
4-dia. vinyl-insulated round cable with 3 conductors  
(Conductor cross section: 0.2 mm<sup>2</sup> (AWG24),  
Insulator diameter: 1.1 mm),  
Standard length: 2 m  
E3S-CL2:  
4-dia. oil-resistant vinyl-insulated round cable with  
3 conductors  
(Conductor cross section area: 0.2 mm<sup>2</sup> (AWG24),  
Insulator diameter: 1.2 mm),  
Standard length: 2 m

Note: The output selector, operation selector, and distance setting adjuster are located inside the cover.



## Terms and Conditions Agreement

### Read and understand this catalog.

Please read and understand this catalog before purchasing the products. Please consult your OMRON representative if you have any questions or comments.

### Warranties.

(a) Exclusive Warranty. Omron's exclusive warranty is that the Products will be free from defects in materials and workmanship for a period of twelve months from the date of sale by Omron (or such other period expressed in writing by Omron). Omron disclaims all other warranties, express or implied.

(b) Limitations. OMRON MAKES NO WARRANTY OR REPRESENTATION, EXPRESS OR IMPLIED, ABOUT NON-INFRINGEMENT, MERCHANTABILITY OR FITNESS FOR A PARTICULAR PURPOSE OF THE PRODUCTS. BUYER ACKNOWLEDGES THAT IT ALONE HAS DETERMINED THAT THE PRODUCTS WILL SUITABLY MEET THE REQUIREMENTS OF THEIR INTENDED USE.

Omron further disclaims all warranties and responsibility of any type for claims or expenses based on infringement by the Products or otherwise of any intellectual property right. (c) Buyer Remedy. Omron's sole obligation hereunder shall be, at Omron's election, to (i) replace (in the form originally shipped with Buyer responsible for labor charges for removal or replacement thereof) the non-complying Product, (ii) repair the non-complying Product, or (iii) repay or credit Buyer an amount equal to the purchase price of the non-complying Product; provided that in no event shall Omron be responsible for warranty, repair, indemnity or any other claims or expenses regarding the Products unless Omron's analysis confirms that the Products were properly handled, stored, installed and maintained and not subject to contamination, abuse, misuse or inappropriate modification. Return of any Products by Buyer must be approved in writing by Omron before shipment. Omron Companies shall not be liable for the suitability or unsuitability or the results from the use of Products in combination with any electrical or electronic components, circuits, system assemblies or any other materials or substances or environments. Any advice, recommendations or information given orally or in writing, are not to be construed as an amendment or addition to the above warranty.

See <http://www.omron.com/global/> or contact your Omron representative for published information.

### Limitation on Liability: Etc.

OMRON COMPANIES SHALL NOT BE LIABLE FOR SPECIAL, INDIRECT, INCIDENTAL, OR CONSEQUENTIAL DAMAGES, LOSS OF PROFITS OR PRODUCTION OR COMMERCIAL LOSS IN ANY WAY CONNECTED WITH THE PRODUCTS, WHETHER SUCH CLAIM IS BASED IN CONTRACT, WARRANTY, NEGLIGENCE OR STRICT LIABILITY.

Further, in no event shall liability of Omron Companies exceed the individual price of the Product on which liability is asserted.

### Suitability of Use.

Omron Companies shall not be responsible for conformity with any standards, codes or regulations which apply to the combination of the Product in the Buyer's application or use of the Product. At Buyer's request, Omron will provide applicable third party certification documents identifying ratings and limitations of use which apply to the Product. This information by itself is not sufficient for a complete determination of the suitability of the Product in combination with the end product, machine, system, or other application or use. Buyer shall be solely responsible for determining appropriateness of the particular Product with respect to Buyer's application, product or system. Buyer shall take application responsibility in all cases.

NEVER USE THE PRODUCT FOR AN APPLICATION INVOLVING SERIOUS RISK TO LIFE OR PROPERTY OR IN LARGE QUANTITIES WITHOUT ENSURING THAT THE SYSTEM AS A WHOLE HAS BEEN DESIGNED TO ADDRESS THE RISKS, AND THAT THE OMRON PRODUCT(S) IS PROPERLY RATED AND INSTALLED FOR THE INTENDED USE WITHIN THE OVERALL EQUIPMENT OR SYSTEM.

### Programmable Products.

Omron Companies shall not be responsible for the user's programming of a programmable Product, or any consequence thereof.

### Performance Data.

Data presented in Omron Company websites, catalogs and other materials is provided as a guide for the user in determining suitability and does not constitute a warranty. It may represent the result of Omron's test conditions, and the user must correlate it to actual application requirements. Actual performance is subject to the Omron's Warranty and Limitations of Liability.

### Change in Specifications.

Product specifications and accessories may be changed at any time based on improvements and other reasons. It is our practice to change part numbers when published ratings or features are changed, or when significant construction changes are made. However, some specifications of the Product may be changed without any notice. When in doubt, special part numbers may be assigned to fix or establish key specifications for your application. Please consult with your Omron's representative at any time to confirm actual specifications of purchased Product.

### Errors and Omissions.

Information presented by Omron Companies has been checked and is believed to be accurate; however, no responsibility is assumed for clerical, typographical or proofreading errors or omissions.

2023.1

In the interest of product improvement, specifications are subject to change without notice.

**OMRON Corporation**  
Industrial Automation Company

<http://www.ia.omron.com/>

(c)Copyright OMRON Corporation 2023 All Right Reserved.